

OMRON

# NS SERIES

One-touch machine management

ONE TOUCH



» High-quality screen with 3-year warranty

» **Connect to any device**

» 'Drag & Drop' simplicity of Smart Active Parts

realizing

## Total control at your fingertips

*Omron's NS series looks like a normal HMI, but it is not. Designed on Smart Platform, the NS series provides enhanced communication even across multiple networks, to manage all devices in a machine for true industrial machine management. We provide functions to let you perform diagnoses and maintenance to make your machine competitive in an easy way. This is why we call it: one touch Machine Management. And that's why it's more than just an HMI terminal!*

### Outstanding connectivity

Used together with Omron PLCs and other field-programmable devices, such as temperature controllers and inverters, the NS series gives enhanced communication and programming capabilities, even across multiple networks, allowing you to manage all devices in your machine from a single terminal.

A built-in USB connection enables simple and fast connection of peripherals, while a built-in Ethernet interface allows fast connection to multiple PLCs and computers.

The NS series is also capable of connecting to many non-Omron devices to give you total flexibility in managing your machine.



# Sysmac One

## Machine management tool vs. HMI terminal

The NS HMI has, beside the generic HMI functions, many other functions to be able to use the NS as a real machine management tool. With the NS HMI you can configure, commission, maintain and operate many Omron devices and even third party devices. This means you can simple configure some settings, display errors or statuses, up- and download parameters all with the NS HMI terminal.

The NS HMI allows you to create and use the diagnostics functions for many devices you need to manage your machine. By providing diagnoses and maintenance functions on the NS, Omron allows a full insight into the machine's state and the flexibility to quickly troubleshoot on-site with minimum of work for the machine builder, system integrator or end-user.

## Proven reliability

For over a decade Omron has been a global supplier of HMI solutions and high-reliability industrial touch-screen technology. Omron has supplied more than 500,000 pieces of HMI through more than 200 Omron Sales & Support offices world-wide, each offering after-sales support, service and training in local languages.



## Integrated Machine Management: Sysmac One series

The Sysmac One series combine an NS touch screen with a powerful CJ1 PLC and the choice of different network interfaces in a compact housing occupying less panel space. Complete transparency enables the PLC, network (including field devices) and HMI to be accessed via a single port – a big advantage when servicing your machine remotely. With the Sysmac One you get the best of both worlds: One touch Machine Management HMI and the flexible, fast and easiest logic controller in the market.







## Smart Platform





Omron's Smart Platform concept enables complete machine and plant automation from one single platform without having to worry about field buses, integration of various software and above all without being locked into one dominant supplier. Smart Platform will minimize the time and effort you spend on automation.

<http://smartplatform.info/>



# NS Series Portfolio

Advanced HMI – NS					
					
<b>Model</b>	<b>NS12</b>	<b>NS10</b>	<b>NS8</b>	<b>NS5</b>	<b>NS5 Handheld</b>
<b>Display</b>	12.1 inch TFT colour	10.4 inch TFT colour	8.4 inch TFT colour	5.7 inch Monochrome or STN/TFT colour	5.7 inch STN colour
<b>Resolution</b>	800x600 pixels	640x480 pixels	640x480 pixels	320x240 pixels	320x240 pixels
<b>Number of colours</b>	256 (32,768 for image data)	256 (32,768 for image data)	256 (32,768 for image data)	Monochrome 16 grey-scales, STN/TFT 256 colours (STN 4096, TFT 32,768 for image data)	256 colours (4096 colours for image data)
<b>Memory Size</b>	60MB screen memory, 32,768 words + 32,768 bits internal memory and 8192 words + 8192 bits retentative memory	60MB screen memory, 32,768 words + 32,768 bits internal memory and 8192 words + 8192 bits retentative memory	60MB screen memory, 32,768 words + 32,768 bits internal memory and 8192 words + 8192 bits retentative memory	60MB screen memory, 32,768 words + 32,768 bits internal memory and 8192 words + 8192 bits retentative memory	60MB screen memory, 32,768 words + 32,768 bits internal memory and 8192 words + 8192 bits retentative memory
<b>Options</b>	Ethernet, Controller Link, Video input board (RGB/Composite)	Ethernet, Controller Link, Video input board (RGB/Composite)	Ethernet, Video input board (RGB/Composite)	Ethernet	RS-232 or RS-422 communication depending on cable
<b>Size in mm (HxWxD)</b>	241x315x48.5	241x315x48.5	177x195x48.5	142x195x54	176x223x70.5 (excl. emergency button)

HMI & Control – SYSMAC One				
				
<b>Model</b>	<b>NSJ12</b>	<b>NSJ10</b>	<b>NSJ8</b>	<b>NSJ5</b>
<b>Display</b>	12.1 inch colour TFT	10.4 inch colour TFT	8.4 inch colour TFT	5.7 inch colour TFT or STN
<b>Display Size / Resolution</b>	246x184.5 mm (800x600 pixels)	215.5x162.4 mm (640x480 pixels)	170.9x128.2 mm (640x480 pixels)	117.2x88.4 mm (320x240 pixels)
<b>Control</b>	CJ1G-CPU45H; 60k-steps program memory, 128k-words data memory, logic instruction time 0.04 µs	CJ1G-CPU45H; 60k-steps program memory, 128k-words data memory, logic instruction time 0.04 µs	CJ1G-CPU45H; 60k-steps program memory, 128k-words data memory, logic instruction time 0.04 µs  CJ1M-CPU13; 20k-steps program memory, 32k-words data memory, logic instruction time 0.04 µs	CJ1G-CPU45H; 60k-steps program memory, 128k-words data memory, logic instruction time 0.04 µs  CJ1M-CPU13; 20k-steps program memory, 32k-words data memory, logic instruction time 0.04 µs
<b>Communication</b>	DeviceNet Master/Slave or PROFIBUS Master and optional Ethernet interface	DeviceNet Master/Slave or PROFIBUS Master and optional Ethernet interface	DeviceNet Master/Slave or PROFIBUS Master and optional Ethernet interface	DeviceNet Master/Slave or PROFIBUS Master and optional Ethernet interface
<b>Expansion (1 board max.)</b>	Ethernet, Controller Link, I/O extension	Ethernet, Controller Link, I/O extension	Ethernet, Controller Link, I/O extension	Ethernet, Controller Link, I/O extension
<b>Size in mm (HxWxD)</b>	Without expansion unit 241x315x73.3 With expansion unit 241x315x89.3	Without expansion unit 241x315x73.3 With expansion unit 241x315x89.3	Without expansion unit 177x232x73.3 With expansion unit 177x232x89.3	Without expansion unit 195x142x79 With expansion unit 195x142x95

# Outstanding Connectivity

## Save time on programming and designing with Smart Active Parts

Unlike conventional visualization objects, Smart Active Parts communicate, across multiple networks, with their corresponding devices. They can be used to configure, commission, operate and maintain these devices, without a single line of code needed to be written in the PLC or the HMI. This allows you to add powerful functionality to your application within minutes.

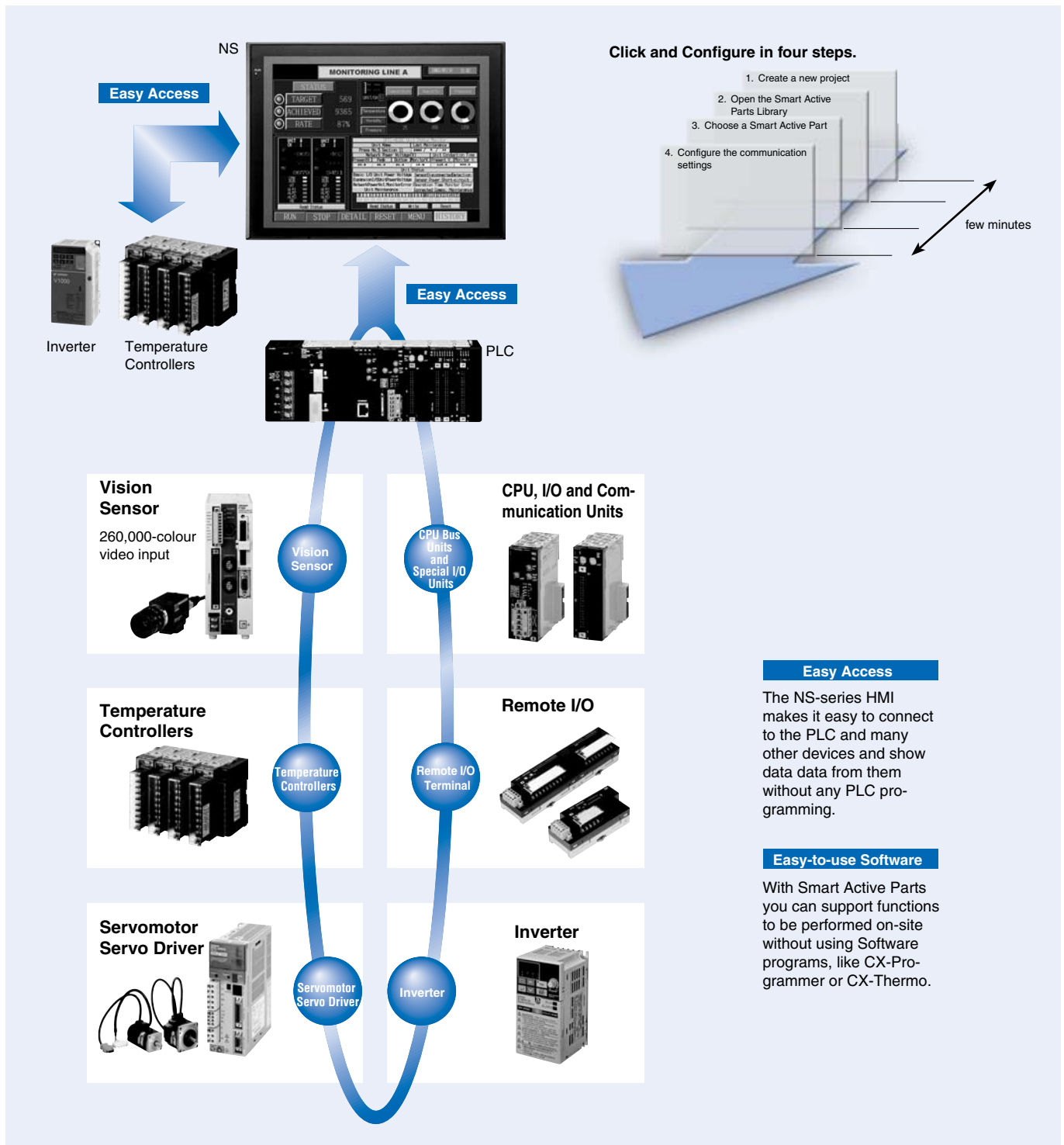

**Using Smart Active Parts: just a few simple steps**

**Dramatically reduces the effort required to create ladder programming and screens.**

A library with more than 2,000 Smart Active Parts is available, which can directly access OMRON PLCs and other devices. You can drag & drop Smart Active Parts in an application in just 4 simple steps.

With Smart Active Parts you can for instance monitor device errors in understandable text, download parameters to devices and check Network statuses without the need for a computer with software tools.

**Example screens using support tool objects (Tool Function SAP Library)**

**From** Computer support tools

**To** PLC CPU Unit monitoring screen, NCF Unit setting screen, DeviceNet monitoring screen

**The SAP library also provides PLC I/O Unit Troubleshooter SAPs**

Troubleshooter Smart Active Parts are available to troubleshoot specific PLC units. When an error occurs in an unit, the Troubleshooter SAP provides an easy-to-understand explanation of the cause of the error as well as which counter measures to take to resolve the error. In this way you can quickly resolve errors on-site even without using documentation.

**Troubleshooter SAP for a Position Control Unit**

NC10Unit Troubleshooter

Error code: 6000

Item name: Emergency stop input

Cause: An emergency stop signal input is received.

Method: At power ON, Data writing

**Troubleshooter SAP for Basic I/O Unit**

CS00 series basic I/O Units troubleshooter

Error Display

Basic I/O Unit Error, I/O setting error, I/O overflow, I/O bus Error, Duplicate Error, Fuse in the Basic I/O Unit is blown, Basic I/O Unit alarm output

Details: An error occurs in a data transfer between the CPU Unit and a Unit mounted to a slot.

Method: Try turning the power OFF and ON again. Turn the power OFF and check cable connections between the device if the error isn't corrected.

**260,000-colour Video Display**

**Display the production steps on the HMI via optional video inputs!**

Two kinds of video interfaces are available to connect to various applications. Provides compatibility with OMRON Vision Sensors (F150, F160, and F250) in addition to video and CCD camera connections. The NS-series HMI contain some useful functions like capturing and browsing images and operating the Console functions in the vision sensor.

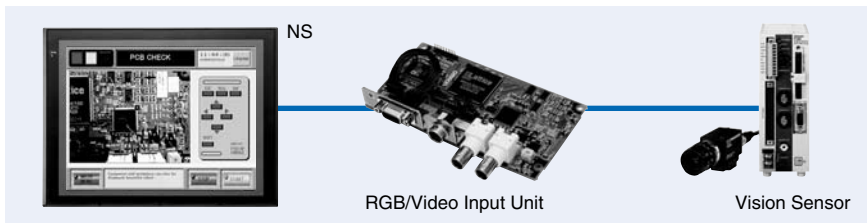

**NS-CA001 Video Input Unit**

Four video inputs or CCD cameras can be connected and up to four images can be displayed simultaneously if the image size is 320x240 pixels.

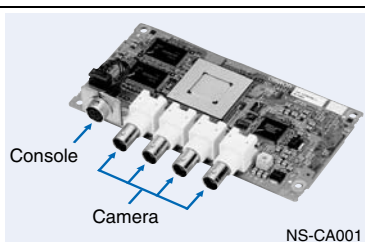

**NS-CA002 RGB/Video Input Unit**

There is an analog RGB input terminal in addition to the two video input terminals. Either the video signals or the analog RGB signal can be displayed on the NS-series HMI.

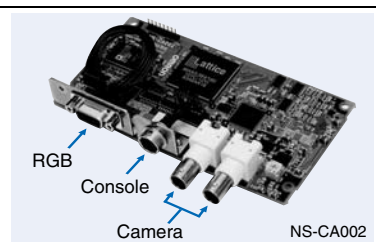

**Single Port Multi Access (SPMA)**

**The PLC program and screen data can be transferred from a single port!**

With SPMA you can transfer the PLC program and HMI project data with one cable connection. It does not even matter if you connect first to HMI or PLC, you can always transfer the data and keep on operating the HMI or PLC.

The HMI can transfer data across different network levels.

Computer (Serial/USB/Ethernet) → NS-series HMI (Ethernet) → PLC (Ethernet or Controller Link) → PLC

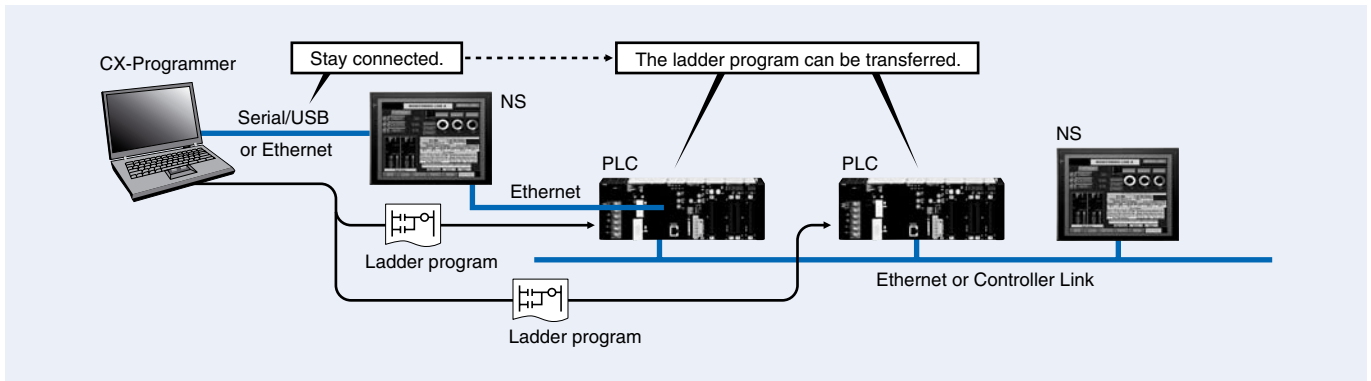

**SPMA significantly improves maintenance efficiency when the NS-series HMI and PLC are connected over longer distances.**

Computer (Serial/USB/Ethernet) → PLC (Serial, Ethernet or Controller Link) → NS-series HMI

**Note:** SPMA can be used in CS/CJ-series PLCs with lot number 030201 or later.

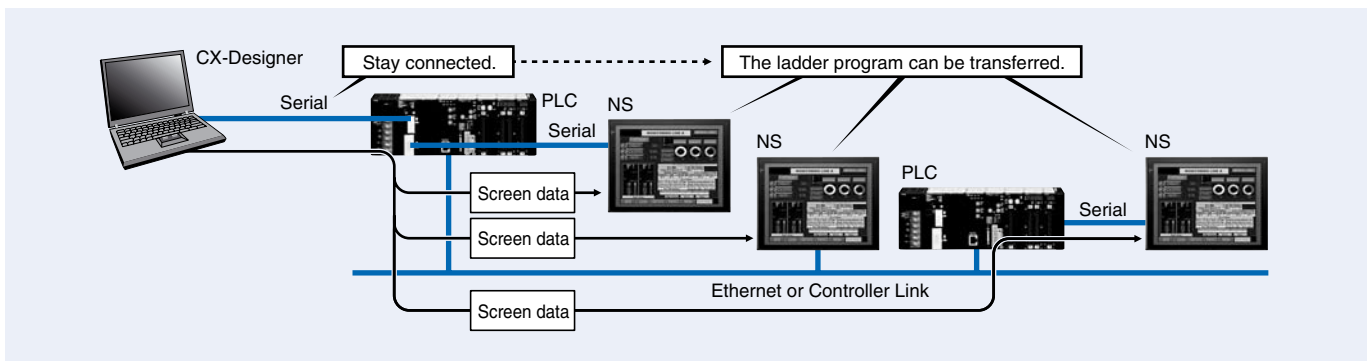

**Direct Connection to Temperature Controllers and Inverters**

**Connect OMRON Temperature Controllers and Inverters to the NS-series HMI.**

OMRON Temperature Controllers can be connected directly to the NS-series HMI RS-232C port. Data does not pass through the PLC, so ladder programming is not required. There are many SAPs in the Library for Temperature Controllers. Temperature Controller screens can be created easily just by pasting objects from the SAP Library onto the screens.

The Omron inverters can also be connected to the NS-series HMI. This makes it easy to read and change parameters for the inverters without any PLC programming.

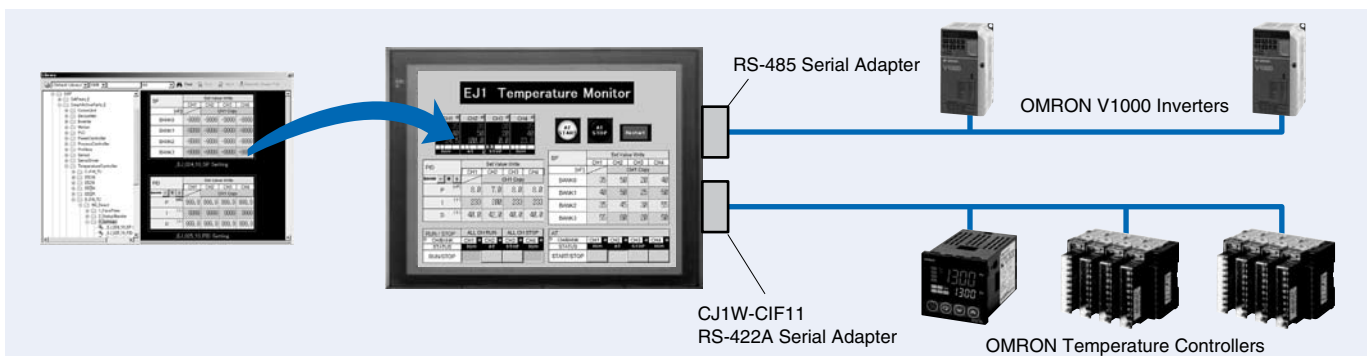

# Exceptional Functionality

## Easy maintenance with the Ladder Monitor

The NS HMI (except for the NS5 series) has a Ladder Monitor built in as a standard feature. A Ladder Monitor is an application that allows you to monitor the ladder program in the CS/CJ series PLC. With the Ladder Monitor you can monitor the execution status of the ladder program in the connected PLC without the need to use software (CX-Programmer). Many useful functions are provided with the Ladder Monitor like viewing I/O comments, monitor and change values, search addresses, easy navigation and capture ladder image.

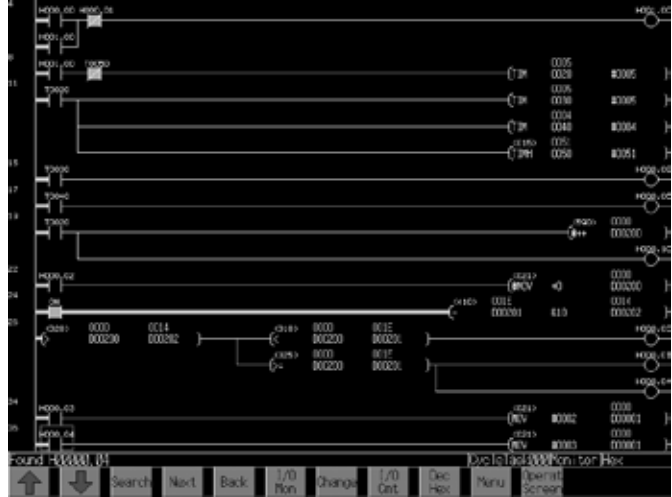

## Easily utilizing advanced functions

### Data block (Recipe) function

Data blocks (recipe function) allow several numeric values and/or character strings to be transferred to/from memory areas, such as PLC data areas. Data blocks can be used to change the system's production setup even faster.

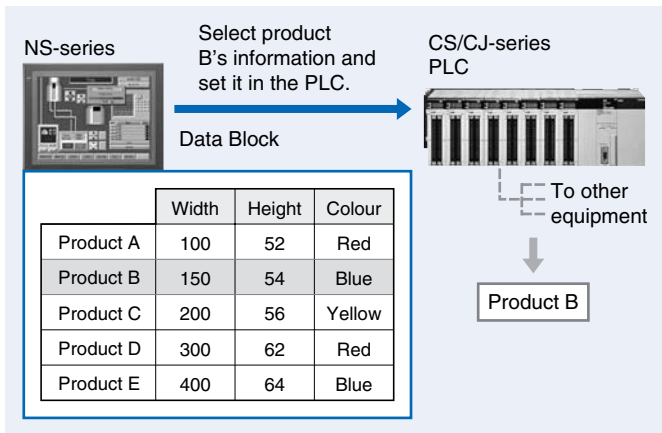

### Communication drivers

The NS-series HMI can connect to several non-Omron devices. This means the NS HMI can have communication on one port to an Omron device and on the second port to a non-Omron device. Contact Omron for up-to-date information on the available communication drivers for the NS HMI series.



### Macro functions

The NS provide an extensive set of macro functions that can be used to perform many different operations.

These functions allows the HMI to process screen display actions or calculate some data, which was performed by PLC before. Also the HMI project can be made more interactive using some macro functions in combination with PLC memory.

Macro functions can be used with screen pages, functional objects, like buttons and lamps or on specific timing operation.

In general we provide macro functions to perform the following actions using Conditional and Logical operations:

- Convert and manipulate data
- Read/Write data to a device
- Perform string manipulation
- Perform screen/popup operations
- Store/retrieve data from CF
- Set date/time
- Influence Screen navigation
- Perform loop operation



## Trend Graphs & Data Logging

### Easily log and display any data over time

A variety of graphing functions are built into the NS-series HMI, such as the trend graph, which can log data over a longer period of time, and the line graph, which can display overlapping graphs.

Logging data is stored as a CSV file in the Memory Card mounted in the NS-series HMI. The data stored in the Memory Card can be read or deleted from the screen.

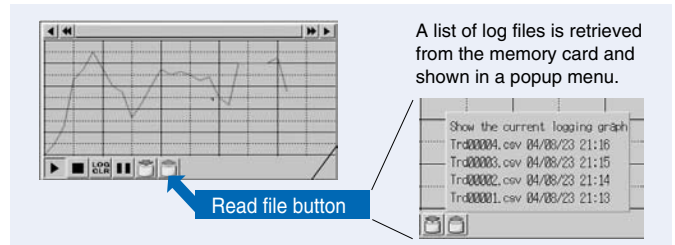

Log files can be saved automatically, just by selecting the Save the data periodically Option in the Data Log Setting Window.

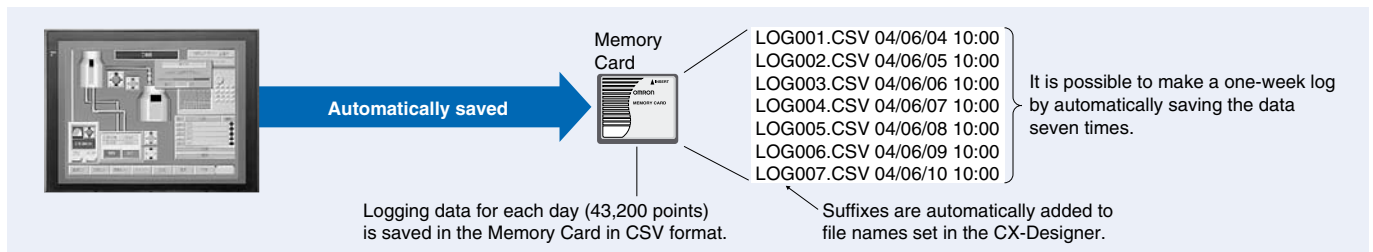

### Trend Graph Function

Data stored/logged by the PLC can be displayed in overlapping graphs, so a device's operation can be compared for evaluation and analysis. In addition, up to 1,000 words of consecutive data can be displayed as a line graph, data can be displayed together, and any region can be magnified.

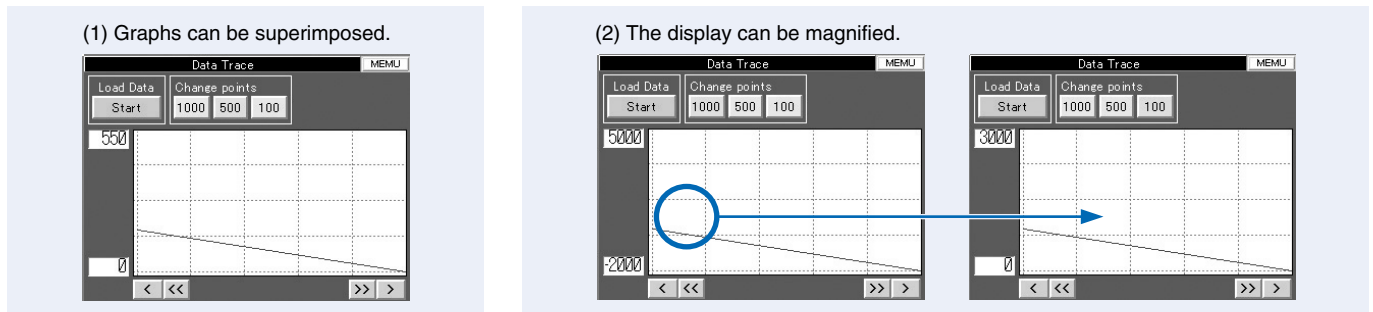

### Continuous Line Graph

A graph can be plotted in any position by specifying the X and Y coordinates of the vertices. Also, the graph can be moved on the screen by specifying the movements from the PLC.

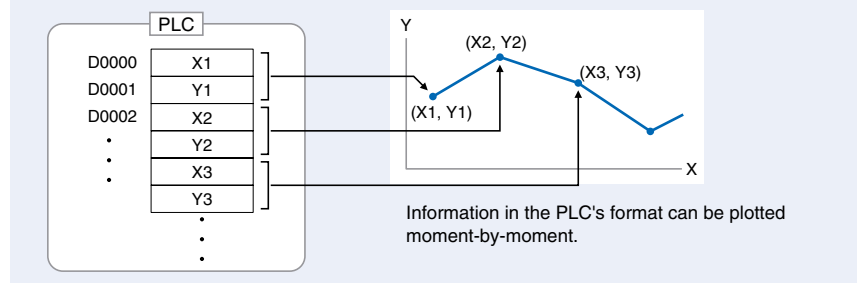

**Diverse Network possibilities to fit any application**

The NS-series provide very strong networking skills. With serial NT-Link communications supporting both 1:1 and 1:N connections you can connect multiple HMI's to the PLC. The NS-series HMI can also support communications with multiple PLCs and multiple HMI's through Controller Link and Ethernet connections, so the network can be configured freely to match the requirements and scale of the application. In addition, using the NS-Runtime makes it possible to monitor machine status and log data from the host.

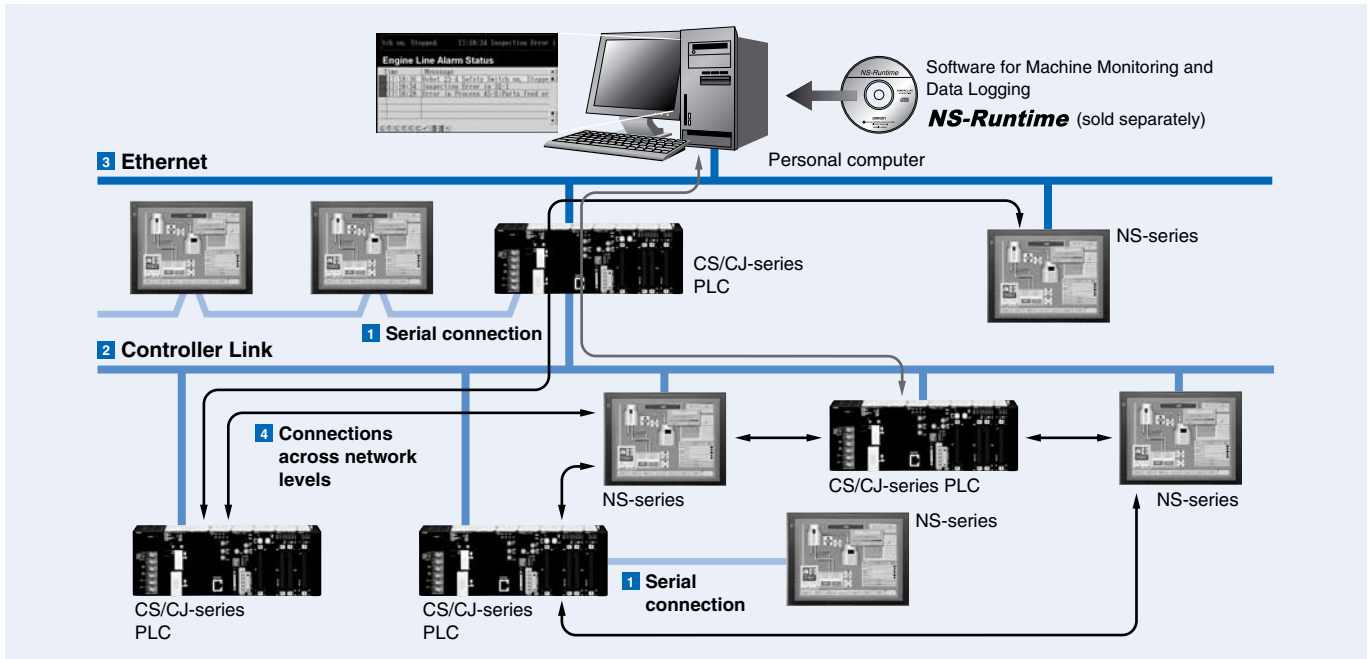

**1 Serial connection**

**1:1 NT Link or Host Link**

NS:PLC = 1:1  
Connecting with the PLC through port A or port B



NS:PLC = 1:2



**1:N NT Link**

NS:PLC ratio = 8:1 max.

Up to 8 NS-series can be connected to each of the PLC's RS-232C/RS-422A ports.

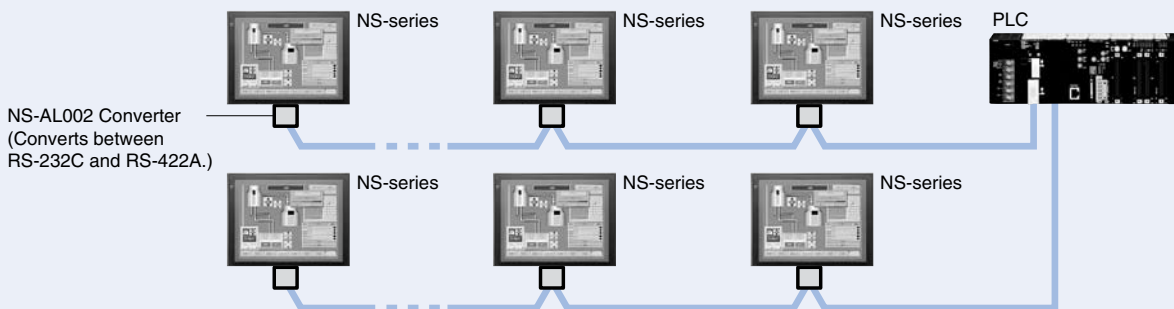

## 2 Controller Link Connection

The HMI can be connected to an OMRON Controller Link network by mounting a Controller Link Interface Unit.

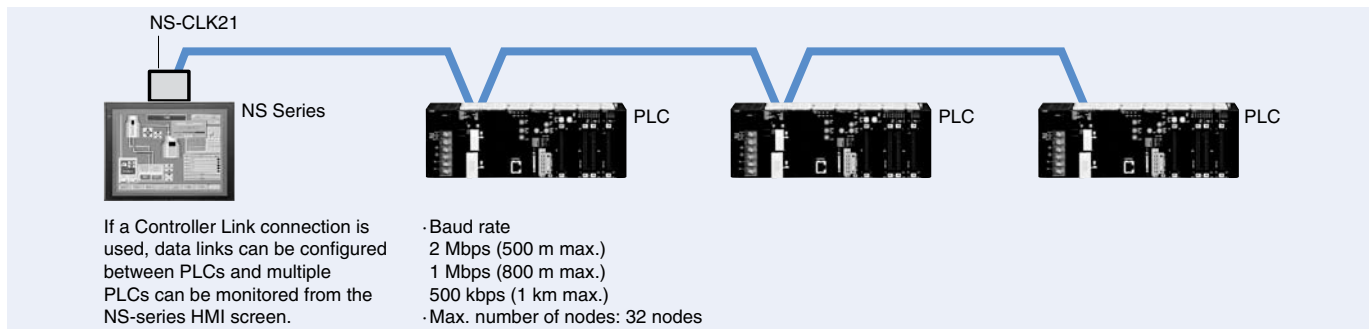

## 3 Ethernet Connection

When using the NS-series HMI with Ethernet you can connect to any Omron controller with an Ethernet port. Beside this you can also use a FTP client to gather data from the NS and even transfer project data to different NS HMI terminals.

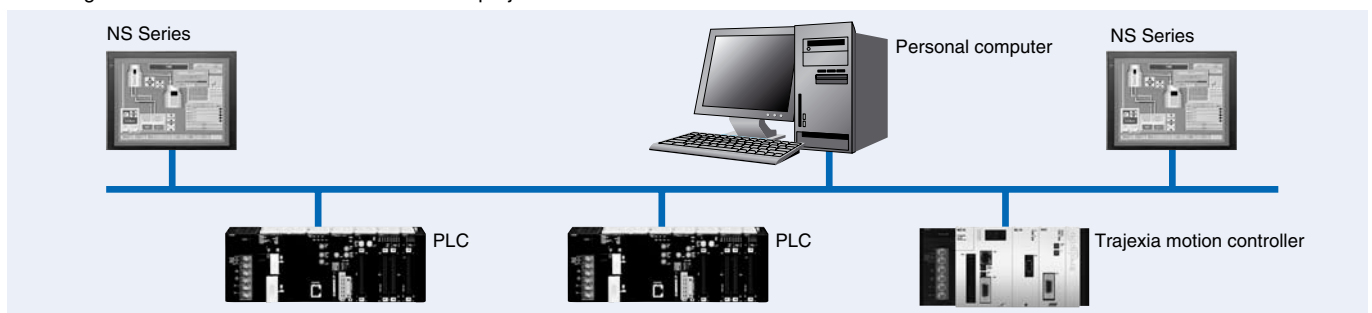

## 4 Connections across Different Network Levels

The NS-series HMI can connect to a variety of devices in the network, through as many as 3 network levels. For example, if SAP (Smart Active Parts) are being used, an NS-series HMI connected by Ethernet can be used to monitor the information in a PLC connected through Controller Link as well as the information in the DeviceNet Slaves connected to that PLC.

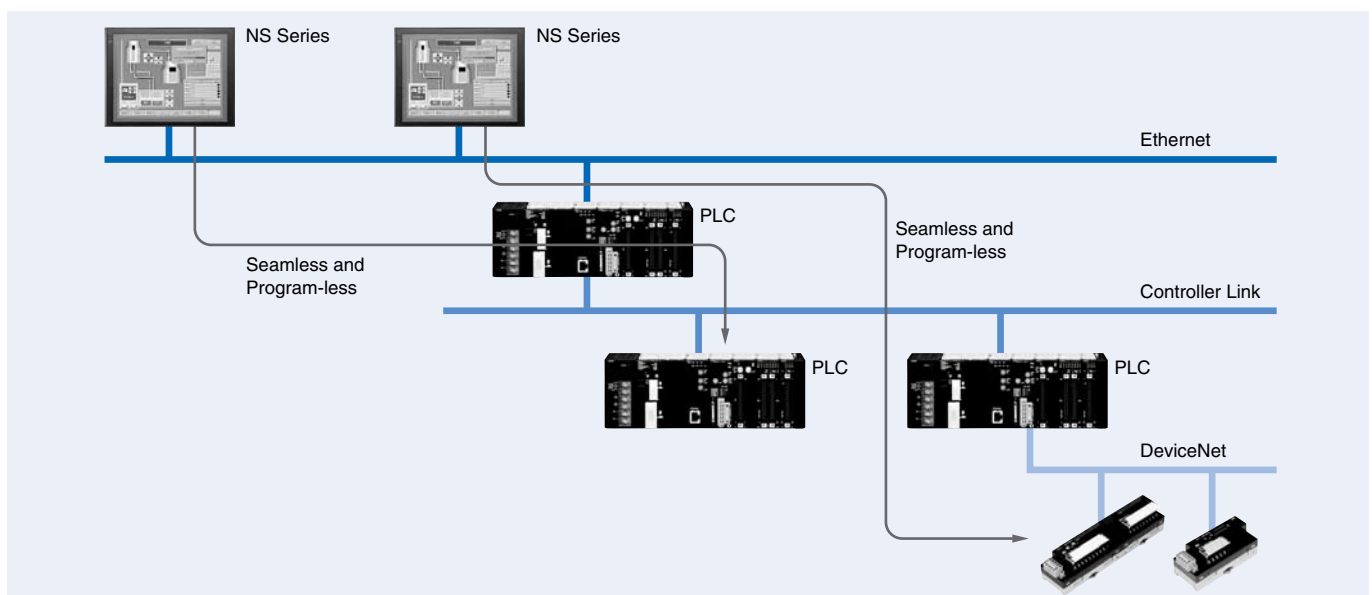

# User-Friendly Software

## Integrated Simulation

**Simulate the HMI program with the PLC program on your PC.**

The integrated simulation function allows you to test the ladder program with the HMI program in an interactive way. You can quickly make changes and test the function to see if it works as desired. Therefore the integrated simulation function significantly increases debugging efficiency.

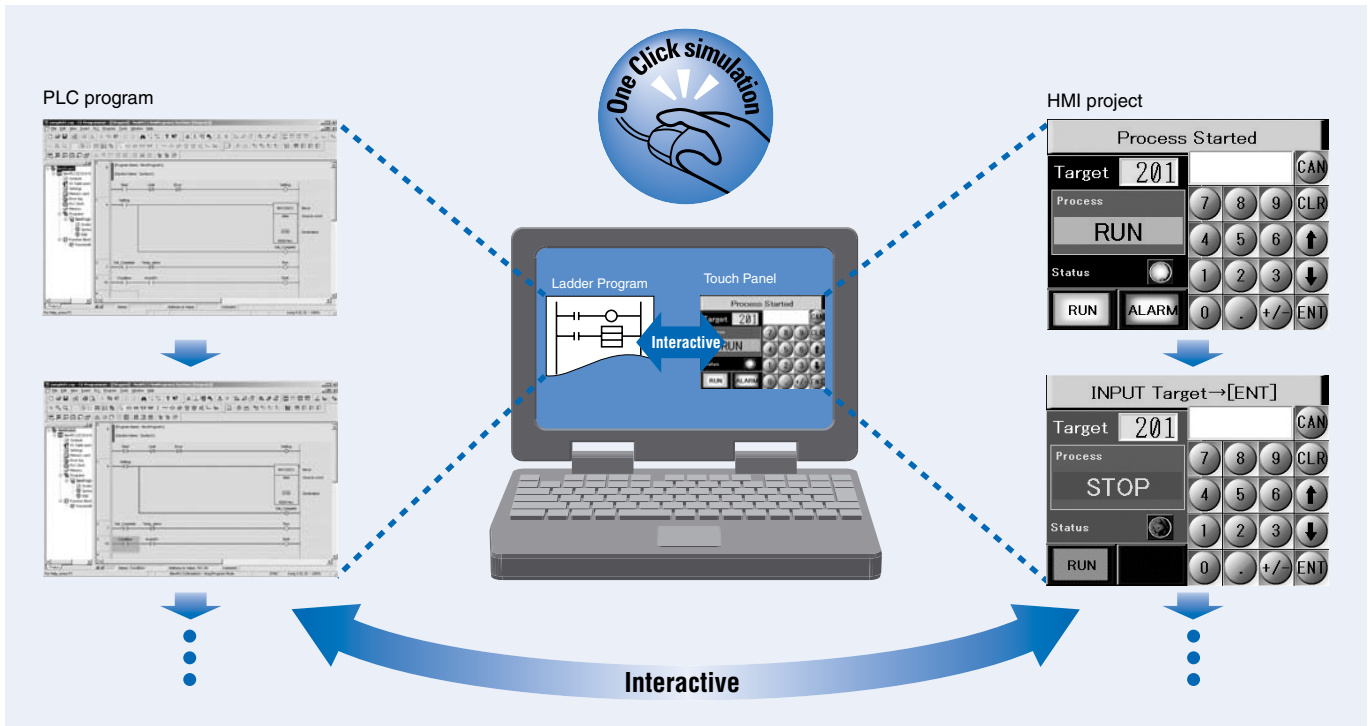

## Programming with Symbols

**Screens can be created even when addresses are unknown.**

Screens can be created even if the addresses have not been determined. Addresses can be input as either names or actual addresses and the addresses can be input from the symbol table after the addresses are determined.

The symbol table created in our PLC programming package, CX-Programmer can be shared with CX-Designer by simply dragging and dropping them in the software.

AUTO	MANU	PARK	SAFE
DOWN	UP	LEFT	RIGHT
MONITOR	PULL	PUSH	RESET

Symbols input for addresses, which have not yet been determined.

Addresses input as addresses because addresses have been determined

SERIAL-PARK

PARK

SERIAL:WR00000.00

AUTO

**[Input from the Symbol Table]**

Host	Name	Type	Address	Type/Number	I/O Comment
All	All	All			
SERIALA	AutoGen03	BOOL	WR00000.00		EMERGENCY STOP
SERIALA	AutoGen02	BOOL	WR00000.00		UPPER LIMIT
SERIALA	AutoGen01	BOOL	WR00000.04		DOWN SWITCH
SERIALA	AutoGen00	BOOL	WR00000.01		MANUAL SWITCH
SERIALA	AutoGen04	BOOL	WR00000.00		ADDT SWITCH
SERIALA	AutoGen03	CHANNEL	00004		FLOOR 5
SERIALA	AutoGen02	CHANNEL	00009		FLOOR 4
SERIALA	AutoGen01	CHANNEL	00000		FLOOR 3
SERIALA	AutoGen00	CHANNEL	00004		FLOOR 2
SERIALA	AutoGen04	CHANNEL	00000		FLOOR 1
SERIALA	LEFT	BOOL			LEFT SWITCH
SERIALA	RIGHT	BOOL			RIGHT SWITCH
SERIALA	SAFE	BOOL			SAFETY SWITCH
SERIALA	PARK	BOOL			PARKING

Addresses are input in the symbol table after the addresses are determined.

## Multi-language Support

### Easily export/import text to translate in many different international languages.

As the NS-series HMI support Unicode you can use many different languages from Asia and Europe. In runtime you can switch between 16 languages.

With CX-Designer it is very easy to export and import texts for translation as it is using CSV format. When you import a new language you can even choose to apply the same label properties (e.g. font, colour, etc.) as an existing language.

**NS Series**

**Multi-language CSV data**

Code	Label	Chinese	Japanese	English
80	Setting Screen	设定画面	設定 画面	Einstellung Des Schirmes
81	Instruction Value	指令値表示	指令値 表示	Operational Des Wertes
82	TARGET	目標値	標正値	ZIEL
83	ALARM MAX	警報上限値	警報 上限値	WARNUNG MAXIMUM
84	ALARM MIN	警報下限値	警報 下限値	WARNUNG MINIMUM
85	OPERATION QUANTITY	操作数量表示	操作 数量	BETRIEB QUANTITÄT
86	MANUAL OPERATION	手動操作画面	手動 操作	HANDBETRIEB
87	OPERATION MAX	操作数量表示上限値	操作数量表示 上限値	BETRIEB MAXIMUM
88	OPERATION MIN	操作数量表示下限値	操作数量表示 下限値	BETRIEB MINIMUM
89	Pulse	脉冲	パルス	Impuls
90	Pulse	脉冲	パルス	Impuls
91	Pulse	脉冲	パルス	Impuls
92	Pulse	脉冲	パルス	Impuls
93	Pulse	脉冲	パルス	Impuls
94	Pulse	脉冲	パルス	Impuls
95	MANUAL OP	开始/停止	开始/ 停止	MANUAL OP
96	AUTO/MANUAL	自动/手動	自動/ 手動	AUTOMATISCH/MANUELL
97	INITIALDZ	指令値強制リセット	指令値強制リセット	INITIALDZ

**Import**

**Setting Screen**

**Import Label CSV File**

**Convenient!**

## Advanced functions

### Remote machine servicing over the WWW

The NS HMI series have a web-interface built into the HMI terminal. The web-interface function allows you to see the local NS HMI screen, which is also seen by the operator, remotely in any standard web browser without the need to install software on your PC. This makes it very easy to see what is happening at the site where the machine is located. You can see the alarms and actual values and even operate the HMI from your remote location.

The web-interface<sup>1)</sup> can run in a monitor mode, which allows you to only monitor certain screens, or it can run in the operation mode so that you can operate the HMI terminal as if you were located at the machine.

You can also show all the files stored on the local CF card, e.g. log files created by the NS data logger, and open or download these files from your remote location.



<sup>1)</sup> Web-interface function will be delivered with CX-One v3.1

# NS-Runtime

## Machine monitoring and reporting at the production site

### Machine Viewer

The NS-Runtime software provides functions equivalent to the NS Series, and enables you to display information and perform operations for a complete production line. NS-Runtime will run the NS project, created with CX-Designer, on Windows XP including the DyaloX Series. Beside the existing NS functionality, the NS-Runtime also provides some additional functions explained in more detail below.

### Data Logger

Data can be logged through background processing, with up to 160,000 points stored in one file. The logged data is stored in CSV format, and data can be displayed on data log graphs.

Example: 160,000 Points

Data can be logged for approximately 7.4 days, assuming data is logged every two seconds for 12 hours a day. By using automatic file saving, data logging can be continued even longer than 7.4 days.

### Display documents

The display document function in NS-Runtime makes it possible to show documents (e.g. PDF file) in the screen itself. This is useful for maintenance instructions or reporting. You can even show a different document every time an alarm occurs.

### Application Startup Function

You can start any user application from NS-Runtime by simply clicking a button. This allows you to open documents like Excel or any other software tool you need to use.

### Wide Screen

Computer output can be displayed on another wide-screen monitor.

XGA (1,024 x 768 dots) and up to a maximum screen size of 3,840 x 2,400 is supported. Alarms occurring in devices or the line can be monitored.

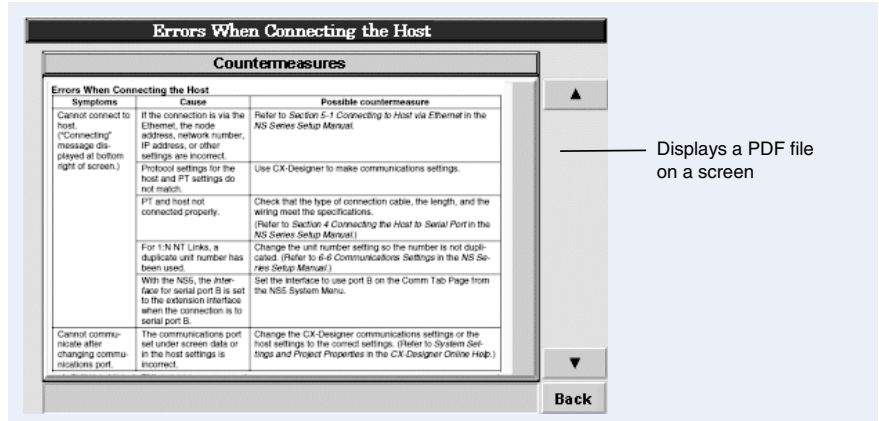

Displays a PDF file on a screen

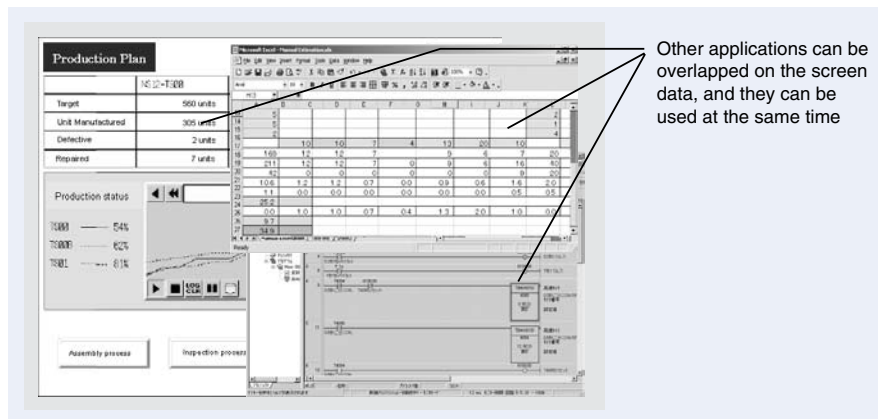

Other applications can be overlapped on the screen data, and they can be used at the same time

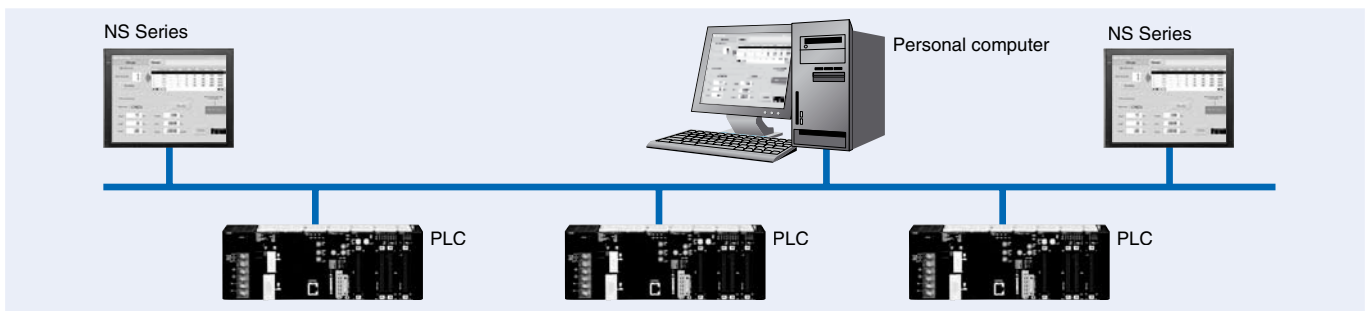

# NSH5 Series

The NSH5 is the mobile version of the NS5 HMI. So it comes with the same strong HMI functions, but allows you to move around the machine with the HMI in your hand. For this we provide the NSH5 with an extremely tough casing that can withstand severe shock and is also completely water resistant.

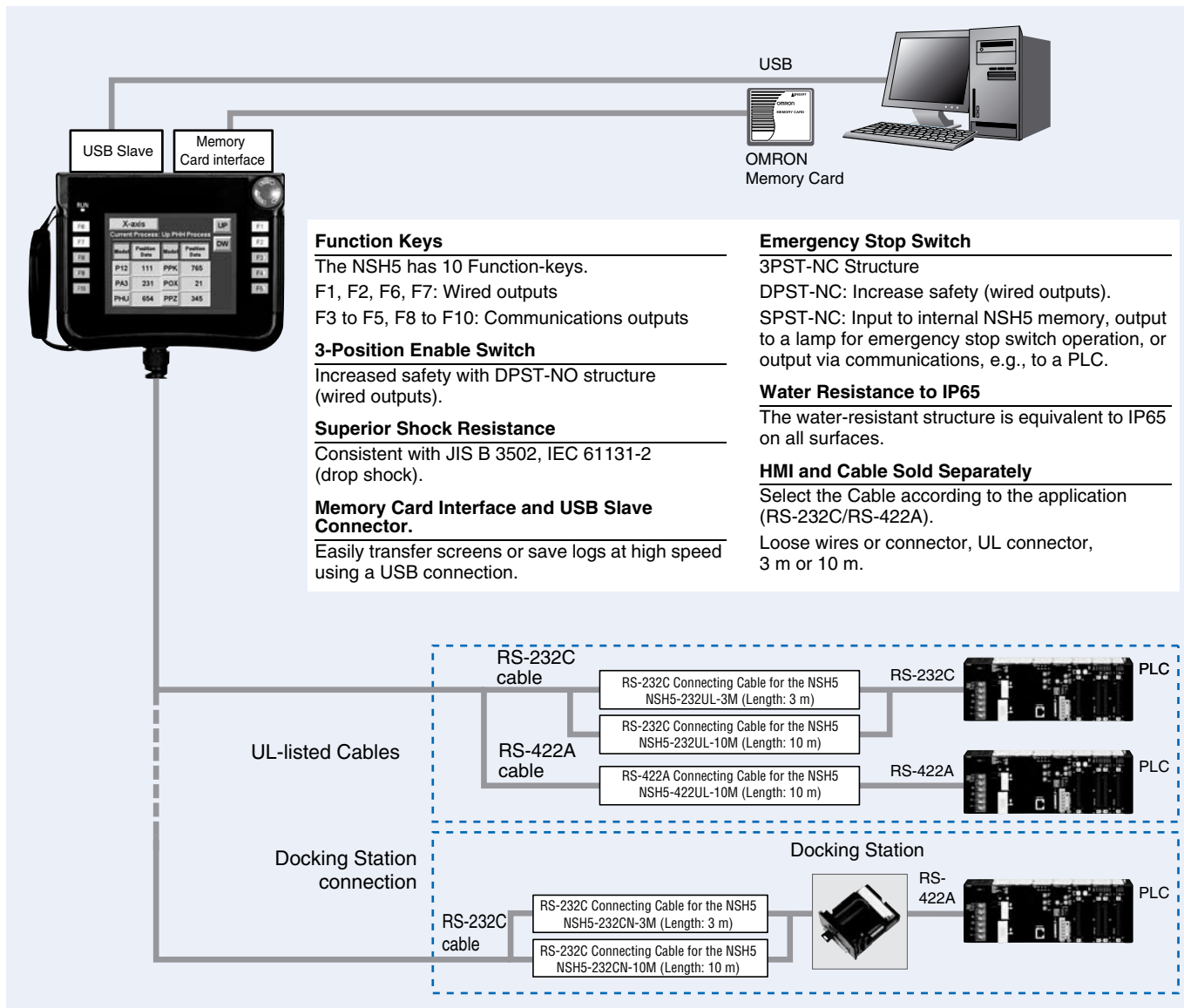

## Options

### Docking Station

The Docking Station is designed in a way that the emergency stop switch line will not turn OFF to trigger the emergency stop circuit even if the NSH5 is disconnected from the station. This eliminates the need for adding an external circuit. Power is disconnected via a key. You can connect a maximum of 15 Docking Stations to a PLC.

### Visor

Installing a visor helps to protect the Emergency Stop Switch and prevents improper operation from occurring inadvertently when the HMI is laid down.



# Sysmac One Series

## Integrated Machine Management: Sysmac One series

The Sysmac One series combine an NS touch screen with a powerful CJ1 PLC and the choice of different network interfaces in a compact housing occupying less panel space. With the standard USB port you can program both the controller part and the graphical display. The Sysmac One series are available in different screen sizes and two different controller types. The controller is running on a separate CPU so that you have the best performance on both screen and controller. Another benefit of this is that the controller can continue operating even if the screen is accidentally broken.

		Display Section					Main Differences in Specifications
		5.7 Inches		8.4 Inches	10.4 Inches	12.1 Inches	
		Colour STN	Colour TFT				
Controller Section (Designated by model number suffix)	M3x	■	■	■	-	-	<ul style="list-style-type: none"> <li>I/O capacity: 640</li> <li>User memory: 20 Ksteps</li> <li>Expanded data memory: None</li> </ul>
	G5x	■	■	■	■	■	<ul style="list-style-type: none"> <li>I/O capacity: 1,280</li> <li>User memory: 60 Ksteps</li> <li>Expanded data memory: 32 Kwords x 3 banks</li> </ul>

## Sysmac One Appearance

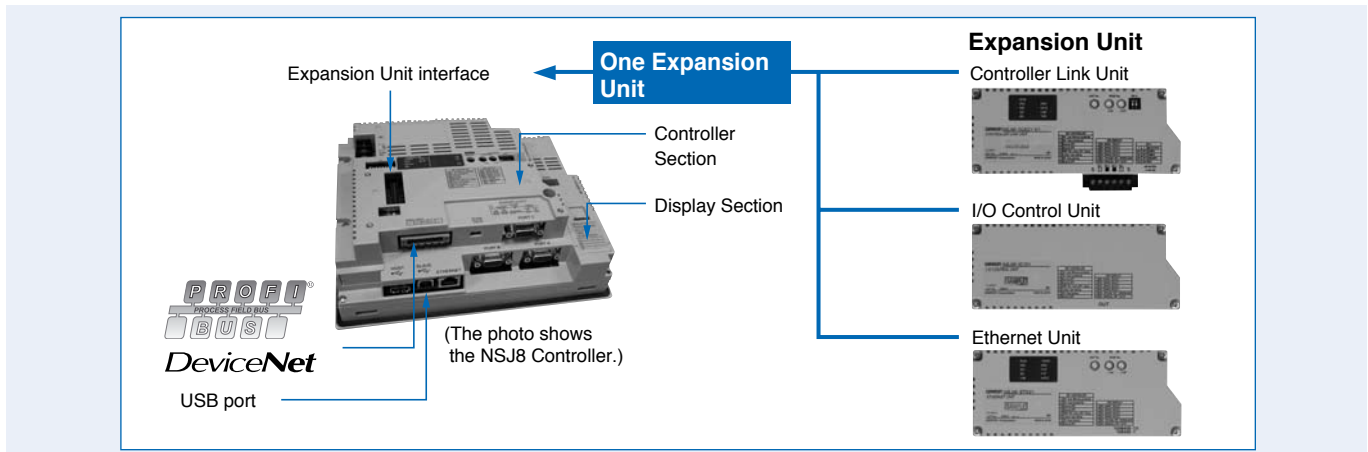

## Easy Maintenance using Troubleshooter function

### Quickly see Errors and Statuses of Controller and Network device

The standard-equipped Troubleshooter contributes to solving problems during device startup and operation. When an error occurs, simply follow the on-screen instructions to confirm the error details and quickly implement counter measures, without referring to the manual.

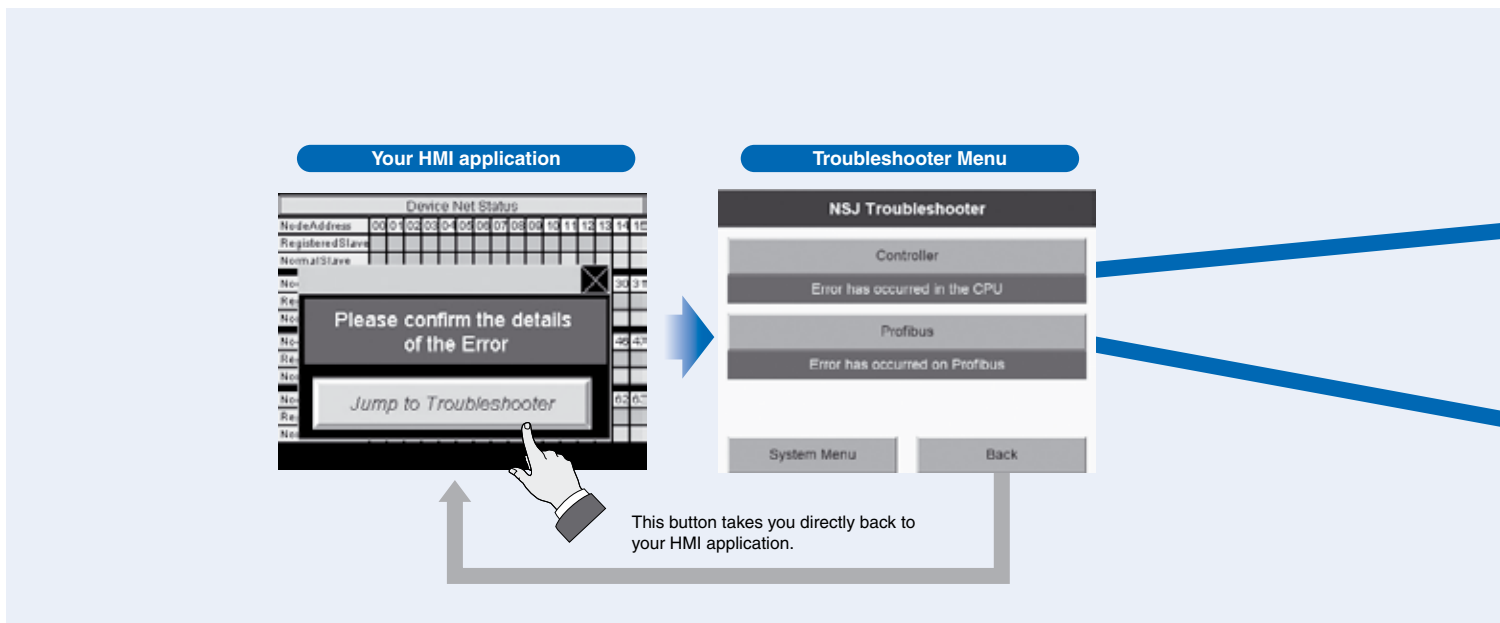



### Expansion Units

For the Sysmac One series we have three different expansion units available. It is only possible to use one expansion unit on a single Sysmac One model. Two expansion units are providing extra network possibilities on Controller Link and Ethernet. The third expansion unit allows you to connect the standard CJ1 units to the Sysmac One model.

#### Controller Link Unit (NSJW-CLK21-V1)

##### High-speed, large-capacity data link

The PLC data link function can be used to provide a high-speed, large-capacity data link between Controllers over the Controller Link network.

#### I/O Control Unit (NSJW-IC101)

##### Easily connect Special I/O Units and CPU Bus Units

Used to mount Motion Control Units and other Special I/O Units or CPU Bus Units to the NSJ-series Controller, for excellent expandability.

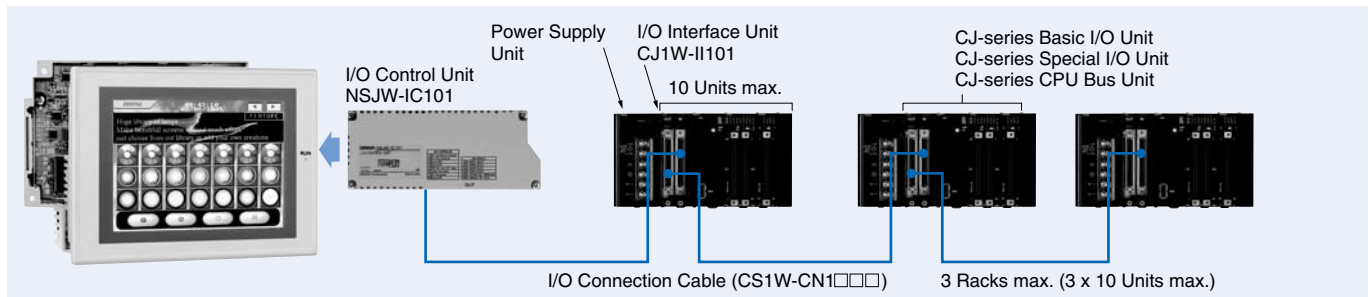

**Note:** Used to mount Motion Control Units and other Special I/O Units or CPU Bus Units to the NSJ-series Controller, for excellent expandability.

#### Ethernet Unit (NSJW-ETN21)

##### Full use of versatile Ethernet functions

The Ethernet expansion unit provides extra Ethernet functions like sending/receiving messages, using CMND instruction and sending/receiving E-mails.

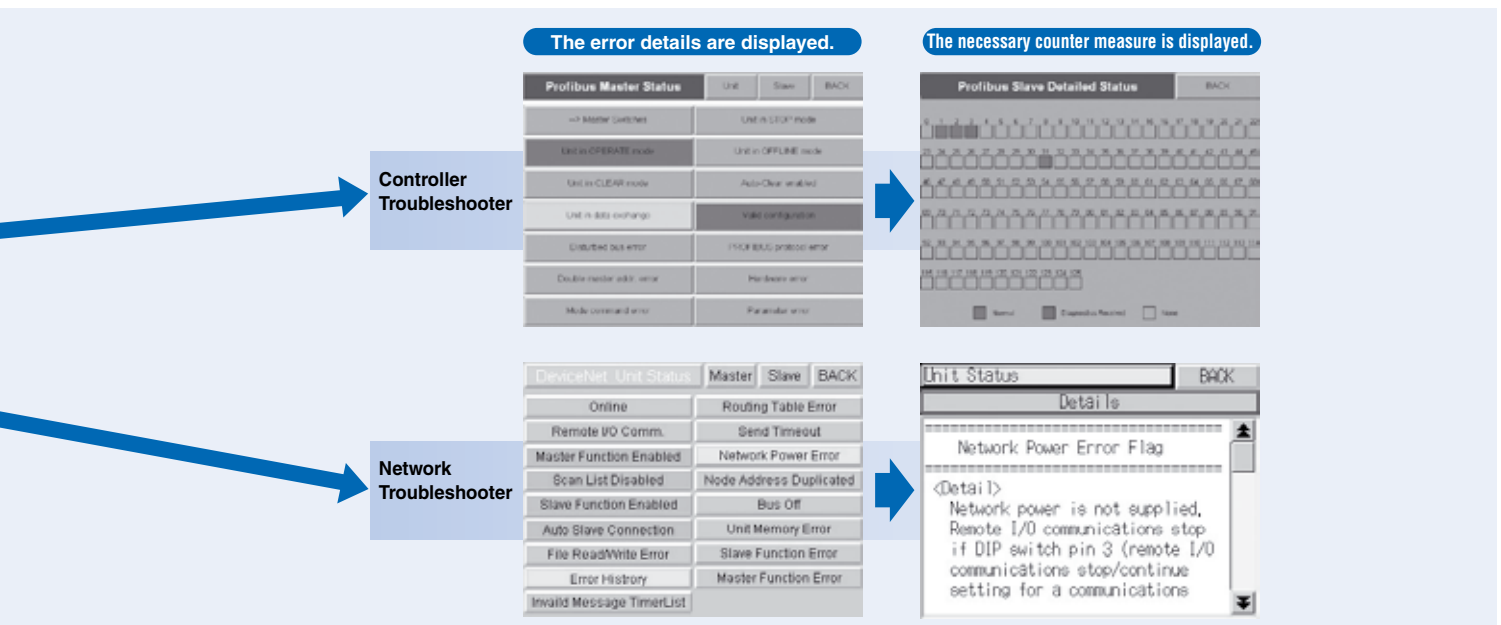
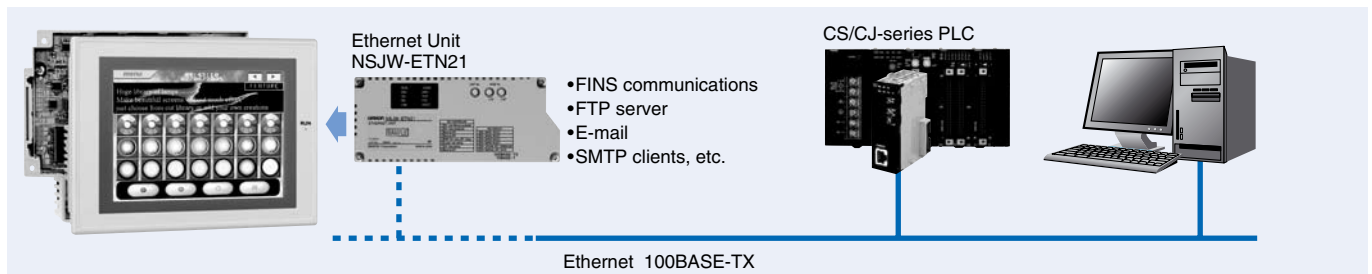

# Control Panel Standardization

By standardizing control panels based on SYSMAC One, design steps can be reduced and software assets can be reused to eliminate redundancy and inconsistency all the way from the design stage to system startup.

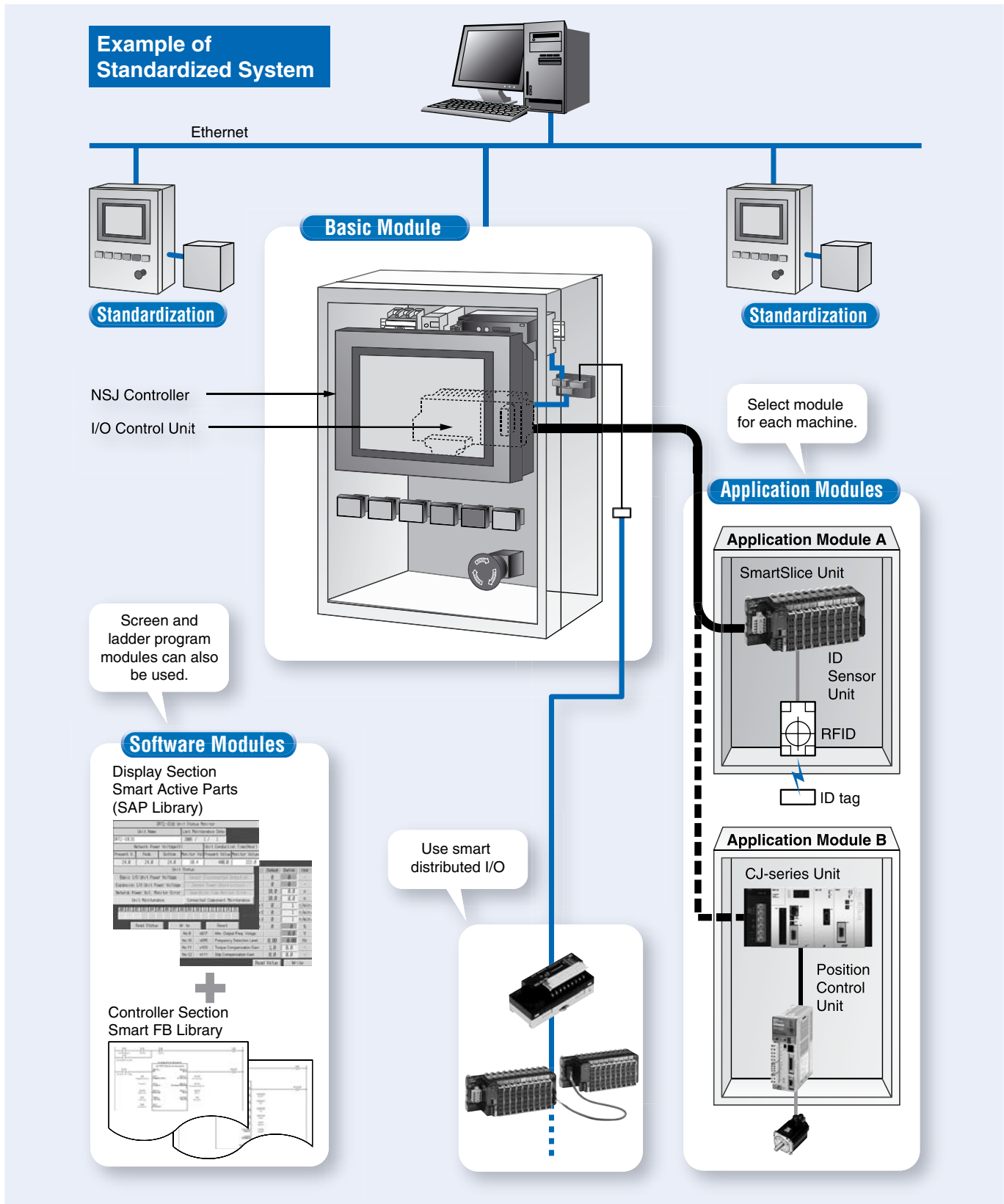

# NS-series HMI: Outstanding connectivity

Many of equipment can be connected to the NS HMI and Sysmac One Series in addition to the variety of highly compatible OMRON control components.

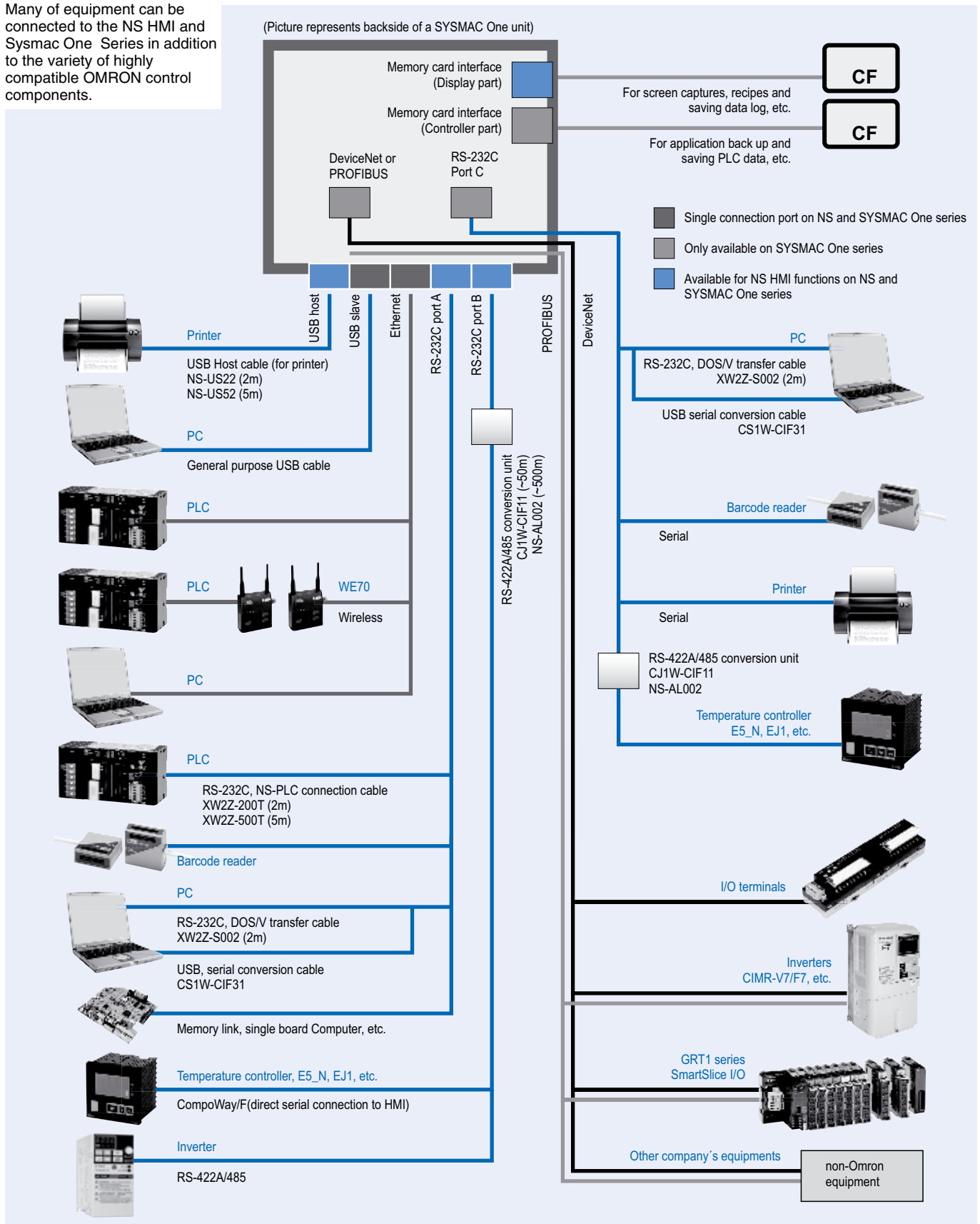

**OMRON EUROPE B.V.** Wegalaan 67-69, NL-2132 JD, Hoofddorp, The Netherlands. Tel: +31 (0) 23 568 13 00 Fax: +31 (0) 23 568 13 88 [www.industrial.omron.eu](http://www.industrial.omron.eu)

**Austria**

Tel: +43 (0) 2236 377 800  
[www.industrial.omron.at](http://www.industrial.omron.at)

**Belgium**

Tel: +32 (0) 2 466 24 80  
[www.industrial.omron.be](http://www.industrial.omron.be)

**Czech Republic**

Tel: +420 234 602 602  
[www.industrial.omron.cz](http://www.industrial.omron.cz)

**Denmark**

Tel: +45 43 44 00 11  
[www.industrial.omron.dk](http://www.industrial.omron.dk)

**Finland**

Tel: +358 (0) 207 464 200  
[www.industrial.omron.fi](http://www.industrial.omron.fi)

**France**

Tel: +33 (0) 1 56 63 70 00  
[www.industrial.omron.fr](http://www.industrial.omron.fr)

**Germany**

Tel: +49 (0) 2173 680 00  
[www.industrial.omron.de](http://www.industrial.omron.de)

**Hungary**

Tel: +36 1 399 30 50  
[www.industrial.omron.hu](http://www.industrial.omron.hu)

**Italy**

Tel: +39 02 326 81  
[www.industrial.omron.it](http://www.industrial.omron.it)

**Netherlands**

Tel: +31 (0) 23 568 11 00  
[www.industrial.omron.nl](http://www.industrial.omron.nl)

**Norway**

Tel: +47 (0) 22 65 75 00  
[www.industrial.omron.no](http://www.industrial.omron.no)

**Poland**

Tel: +48 (0) 22 645 78 60  
[www.industrial.omron.pl](http://www.industrial.omron.pl)

**Portugal**

Tel: +351 21 942 94 00  
[www.industrial.omron.pt](http://www.industrial.omron.pt)

**Russia**

Tel: +7 495 648 94 50  
[www.industrial.omron.ru](http://www.industrial.omron.ru)

**South-Africa**

Tel: +27 (0)11 579 2600  
[www.industrial.omron.co.za](http://www.industrial.omron.co.za)

**Spain**

Tel: +34 913 777 900  
[www.industrial.omron.es](http://www.industrial.omron.es)

**Sweden**

Tel: +46 (0) 8 632 35 00  
[www.industrial.omron.se](http://www.industrial.omron.se)

**Switzerland**

Tel: +41 (0) 41 748 13 13  
[www.industrial.omron.ch](http://www.industrial.omron.ch)

**Turkey**

Tel: +90 216 474 00 40  
[www.industrial.omron.com.tr](http://www.industrial.omron.com.tr)

**United Kingdom**

Tel: +44 (0) 870 752 08 61  
[www.industrial.omron.co.uk](http://www.industrial.omron.co.uk)

**More Omron representatives**  
[www.industrial.omron.eu](http://www.industrial.omron.eu)

*Authorised Distributor:*

**Control Systems**

• Programmable logic controllers • Human-machine interfaces • Remote I/O

**Motion & Drives**

• Motion controllers • Servo systems • Inverters

**Control Components**

• Temperature controllers • Power supplies • Timers • Counters • Programmable relays  
• Digital panel indicators • Electromechanical relays • Monitoring products • Solid-state relays  
• Limit switches • Pushbutton switches • Low voltage switch gear

**Sensing & Safety**

• Photoelectric sensors • Inductive sensors • Capacitive & pressure sensors • Cable connectors  
• Displacement & width-measuring sensors • Vision systems • Safety networks • Safety sensors  
• Safety units/relay units • Safety door/guard lock switches